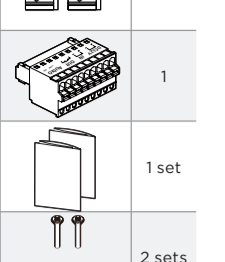
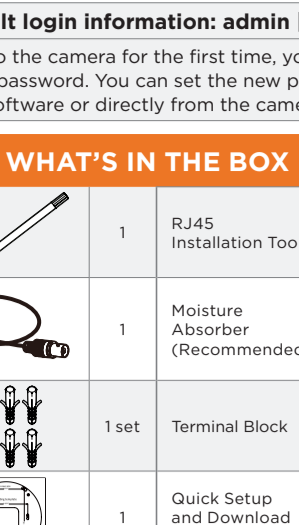

# MEGAPIX Ai™

Next-generation video analytics

**DWC-XSDJ08MI****Default login information: admin | admin**

When logging into the camera for the first time, you will be prompted to set up a new password. You can set the new password using the DW™ IP Finder™ software or directly from the camera's browser menu.

**WHAT'S IN THE BOX**

Star Wrench (T-20)		1	RJ45 Installation Tool		1
Test Monitor Cable		1	Moisture Absorber (Recommended)		1
Screws and Plastic Anchors - 4pcs		1 set	Terminal Block		1
Mounting Template		1	Quick Setup and Download Guides		1 set
Grommet		1	A: #6-32 1/2" screws - 4 pcs B: #6-32 1/2" screws - 2pcs		2 sets

**NOTE:** Download all your support materials and tools in one place

- Go to: <http://www.digital-watchdog.com/resources>
- Search your product by entering the part number in the 'Search by Product' search bar. Results for applicable part numbers will populate automatically based on the part number you enter.
- Click 'Search'. All supported materials, including manuals and quick start guide (QSGs) will appear in the results.

**Attention:** This document is intended to serve as a quick reference for the initial set-up. It is recommended that the user read the entire instruction manual for complete and proper installation and usage.

**SAFETY AND WARNING INFORMATION**

Read through this Installation Guide carefully before installing the product. Keep the Installation Guide for future reference. See the user manual for more information on the proper installation, use and care of the product. These instructions are intended to ensure that users can use the product correctly to avoid danger or property loss. Warnings: Serious injury or death may occur if any of the warnings are neglected. Cautions: Injury or equipment damage may occur if any of the cautions are neglected.

- WARNING**
- In the use of the product, you must be strict compliance with the electrical safety regulations of the nation and region. When the product is mounted on a wall or ceiling, the device shall be firmly fixed.
  - Do not use any standard adapter specified in the specification sheet. Using any other adapter could cause fire, electrical shock, or damage to the product.
  - Make sure the power supply voltage is correct before using the camera.
  - Incorrectly connecting the power supply or replacing the battery may cause an explosion, fire, electric shock, or damage to the product.
  - Do not connect multiple cameras to a single adapter. Exceeding the capacity may cause excessive heat generation or fire.
  - Securely plug the power cord into the power source. An insecure connection may cause a fire.
  - When installing the camera, fasten it securely and firmly. A falling camera may cause personal injury.
  - Do not install in a location subject to elevated temperature, low temperature, or high humidity. Doing so may cause fire or electric shock.
  - Do not place conductive objects (e.g. screwdrivers, coins, metal items, etc.) or containers filled with water on top of the camera. Doing so may cause personal injury due to fire, electric shock or falling objects.
  - Do not install in humid, dusty, or sooty locations. Doing so may cause fire or electric shock.
  - Do not install near any heat sources such as radiators, heat registers, or other products (including amplifiers) that produce heat.
  - Keep out of direct sunlight and heat radiation sources. It may cause a fire.
  - If any unusual smells or smoke come from the unit, stop using the product at once. Immediately disconnect the power source and contact the service center. Continued use in such a condition may cause fire or electric shock.
  - If this product does not operate normally, contact the nearest service center. Never disassemble or change this product in any way.
  - Do not install near any heat sources such as radiators, heat registers, or other products (including amplifiers) that produce heat.
  - Keep out of direct sunlight and heat radiation sources. It may cause a fire.
  - If any unusual smells or smoke come from the unit, stop using the product at once. Immediately disconnect the power source and contact the service center. Continued use in such a condition may cause fire or electric shock.
  - If this product does not operate normally, contact the nearest service center. Never disassemble or change this product in any way.
  - Do not install near any heat sources such as radiators, heat registers, or other products (including amplifiers) that produce heat.
  - Keep out of direct sunlight and heat radiation sources. It may cause a fire.
  - If any unusual smells or smoke come from the unit, stop using the product at once. Immediately disconnect the power source and contact the service center. Continued use in such a condition may cause fire or electric shock.
  - If this product does not operate normally, contact the nearest service center. Never disassemble or change this product in any way.
  - Do not install near any heat sources such as radiators, heat registers, or other products (including amplifiers) that produce heat.
  - Keep out of direct sunlight and heat radiation sources. It may cause a fire.
  - If any unusual smells or smoke come from the unit, stop using the product at once. Immediately disconnect the power source and contact the service center. Continued use in such a condition may cause fire or electric shock.
  - If this product does not operate normally, contact the nearest service center. Never disassemble or change this product in any way.

- CAUTION**
- Use proper safety gear when installing and wiring the product.
  - Do not touch objects on the product or apply strong shock to it. Keep away from a location subject to excessive vibration or magnetic interference.
  - Do not use this product near water.
  - The product shall not be exposed to dripping or splashing and no objects filled with liquids, such as vases, shall be placed on the camera.
  - Avoid aiming the camera directly towards extremely bright objects such as the sun, as this may damage the image sensor.
  - The Main plug is used as a disconnect device and shall stay operable at any time.
  - Remove the power adapter from the outlet when there is lightning. Neglecting to do so may cause fire or damage to the product.
  - Do not block any ventilation openings. Install following the manufacturer's instructions.
  - A polarized or grounding-type plug is recommended for this product. A polarized plug has two blades with one wider than the other. A grounding-type plug has two blades and a third grounding prong. If the provided plug does not fit into your outlet, consult an electrician for replacement.
  - Protect the power cord from being walked on or pinched particularly at plugs, convenience receptacles, and the point where they exit from the product.
  - If any laser equipment is used near the product, make sure the surface of the sensor is not exposed to the laser beam as that may damage the sensor module.
  - If you want to move the already installed product, be sure to turn off the power and then move or reinstall it.
  - Proper configuration of all passwords and other security settings is the responsibility of the installer and/or end-user.
  - If cleaning is necessary, please use a clean cloth to wipe it gently. If the device will not be used for a long time, please cover the lens cap to protect the device from dust.
  - Do not touch the camera's lens or sensor module with fingers. If cleaning is necessary, please use a clean cloth to wipe it gently. If the device will not be used for a long time, please cover the lens cap to protect the device from dust.
  - Use only attachments/accessories specified by the manufacturer.
  - Always use hardware (e.g. screws, anchors, bolts, locking nuts, etc.) compatible with the mounting surface and of sufficient length and construction to ensure a secure mount.
  - Use only with cart, stand, tripod, bracket, or table specified by the manufacturer, or sold with the product.
  - Unplug this product when a qualified service personnel. Use caution when moving the cart/product combination to avoid injury from dirt.
  - Refer all servicing to certified service personnel. Servicing is needed when the product has been damaged in any way, such as power supply cord or plug is damaged, liquid has been spilled or objects have fallen into the product, the product has been exposed to rain or moisture, does not operate normally, or has been dropped.

**STEP 1 - PREPARING TO MOUNT THE CAMERA**

- For the installation, remove the dome using the wrench included with the camera to loosen the four (4) screws on the base of the dome. Remove the protection film between the dome and the camera module.
- Detach the camera module from the junction box and gang box bracket. Using the wrench included with the camera, loosen the three (3) screws connecting the camera module to the junction box and the three (3) screws connecting the junction box to the gang box bracket.

**NOTE:** The camera module is connected to the junction box with both screws and a magnetic holder. Use caution when removing the camera module from the junction box to not damage the magnetic holder.

- Remove the existing moisture packet and insert the new packet in its place. The camera will generate enough heat to dry moisture during operation. In case of a moisture issue, keep the moisture absorber in the camera for up to six (6) months.

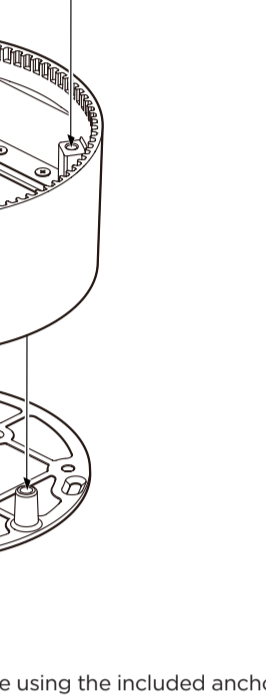

**WARNING:** The moisture absorber prevents moisture buildup inside the camera, which may cause image performance and damage the camera.

- Using the mounting template sheet or the camera's junction box itself, mark and drill the necessary holes in the mounting surface.

**STEP 2 - POWERING THE CAMERA**

Pass the wires through the camera's junction box and make all necessary connections.

- Use a PoE Switch or PoE Injector to connect data and power to the camera using a single Ethernet cable.
- OR
- Use a non-PoE Switch to connect data using an Ethernet cable and use a power adapter to power the camera.

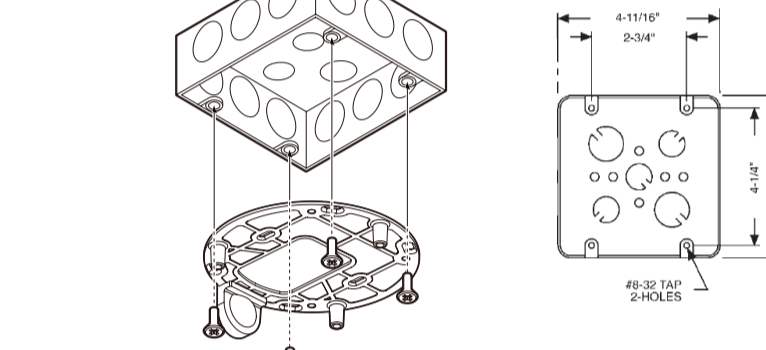

Power requirements	Power consumption
DC12V, PoE IEEE 802.3af Class3 (Adapter not included)	DC: max 13.1W, 1.09A PoE: max 15.0W

**Resetting the camera:** With the camera ON, press the reset button above the SD card slot for five (5) seconds to initiate a camera-wide reset of all the settings, including network settings.

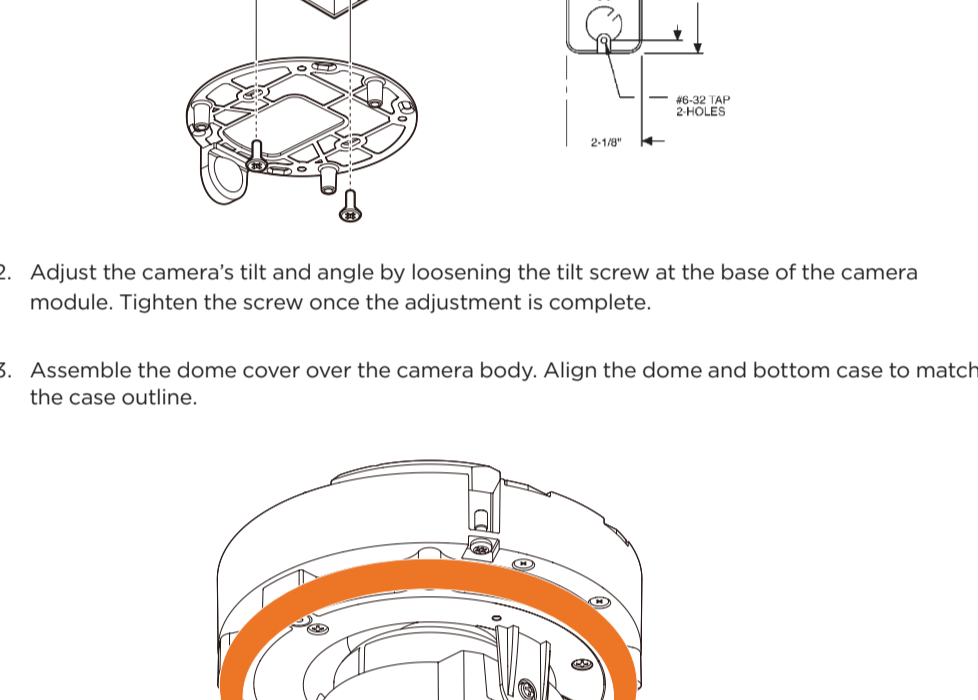
**STEP 3 - INSTALLING THE CAMERA**

- Attach the gang box bracket to the mounting surface using the included anchors and screws. Please note that the camera cannot be mounted without the gang box bracket.

Use the 4 screws (A) included with the converter plate when using a 2-gang handy electrical box or switch box.

Use the 2 screws (B) included with the converter plate when using a 1-gang handy electrical box. Tighten the red-color screws to assemble the bottom junction box and camera module.

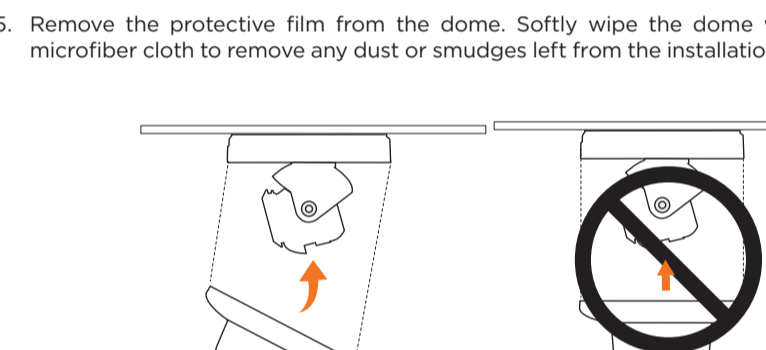

- Adjust the camera's tilt and angle by loosening the tilt screw at the base of the camera module. Tighten the screw once the adjustment is complete.

- Assemble the dome cover over the camera body. Align the dome and bottom case to match the case outline.

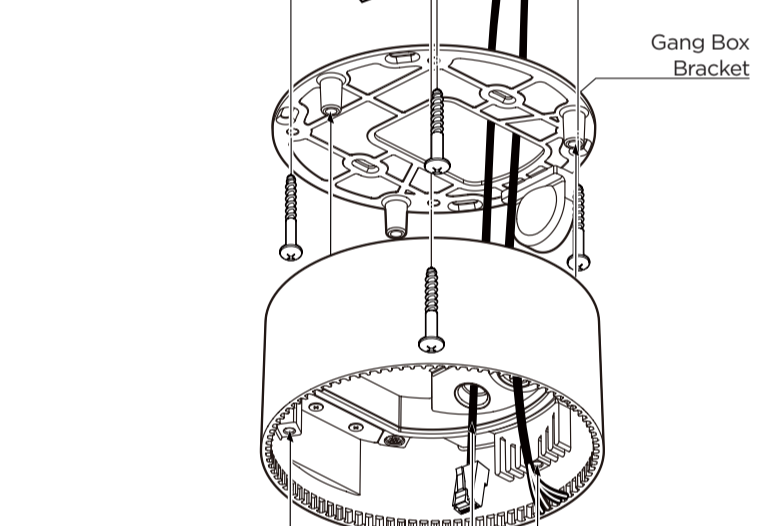

**NOTE:** When setting up the camera for the first time, use the CALIBRATE button on the camera's web GUI to auto calibrate the camera's lens before operation.

- Remove the protective film from the dome. Softly wipe the dome with lens tissue or a microfiber cloth to remove any dust or smudges left from the installation process.

**NOTE:** Be careful not to alter the direction of the camera module.

- Remove the protective film from the dome. Softly wipe the dome with lens tissue or a microfiber cloth to remove any dust or smudges left from the installation process.

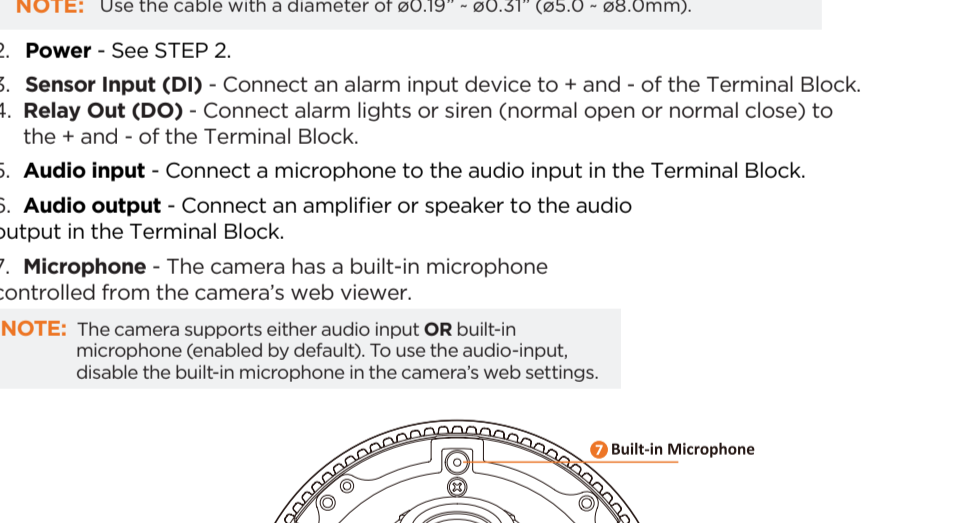
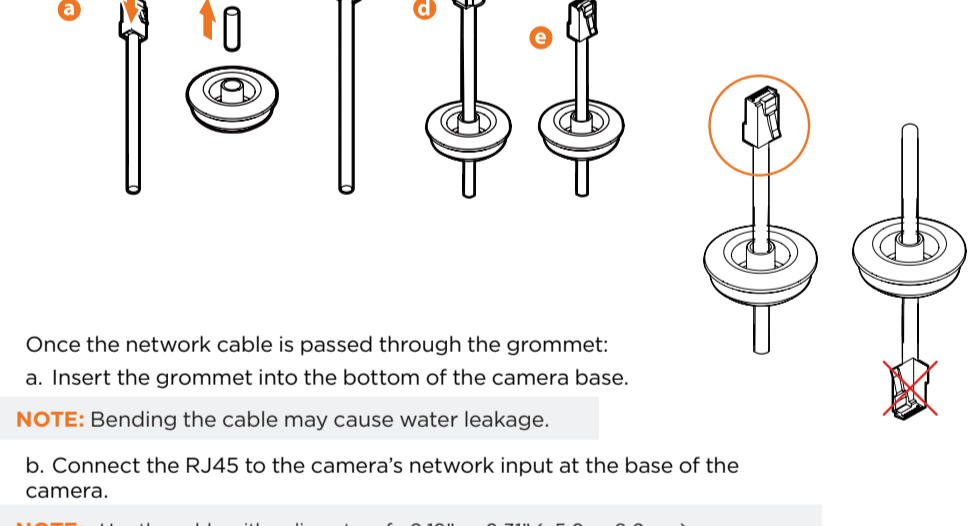
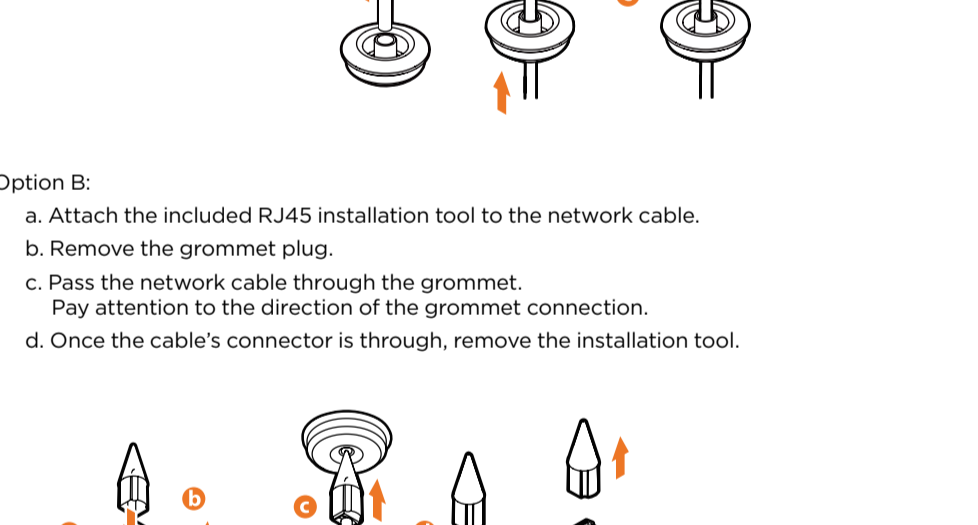
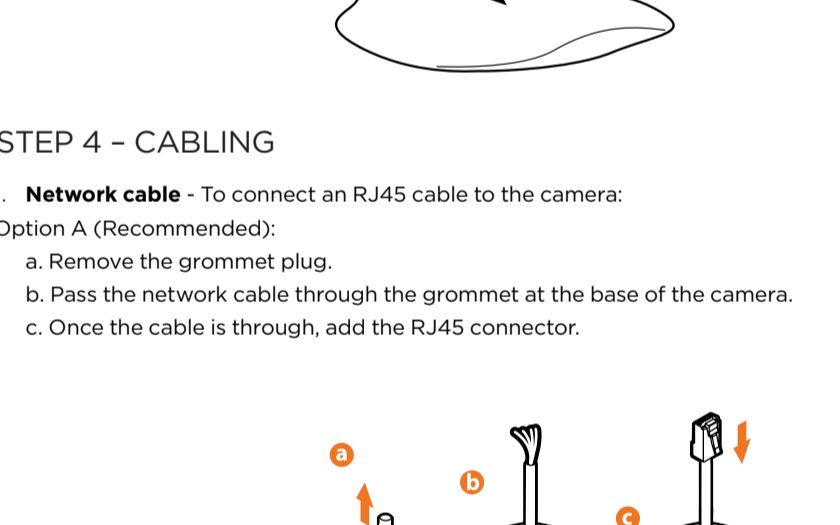
**STEP 4 - CABLING**

- Network cable** - To connect an RJ45 cable to the camera:

**Option A (Recommended):**

- Remove the grommet plug.
- Pass the network cable through the grommet at the base of the camera.
- Once the cable is through, add the RJ45 connector.

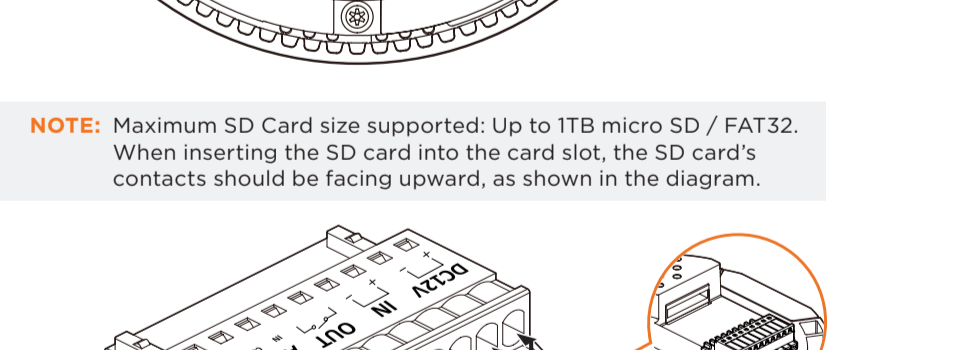

**Option B:**

- Attach the included RJ45 installation tool to the network cable.
- Remove the grommet plug.
- Pass the network cable through the grommet.
- Pay attention to the direction of the grommet connection.
- Once the cable's connector is through, remove the installation tool.

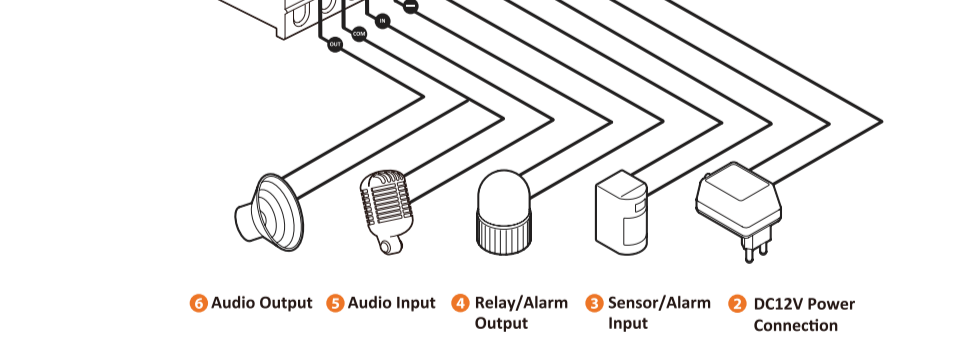

Once the network cable is passed through the grommet:

- Insert the grommet into the bottom of the camera base.

**NOTE:** Bending the cable may cause water leakage.

- Connect the RJ45 to the camera's network input at the base of the camera.

**NOTE:** Use the cable with a diameter of ø0.19" - ø0.31" (ø5.0 - ø8.0mm).

- Power** - See STEP 2.
- Sensor Input (DIY)** - Connect an alarm input device to a and - of the Terminal Block.
- Relay Out (DO)** - Connect alarm lights or siren (normal open or normal close) to the + and - of the Terminal Block.
- Audio Input** - Connect a microphone to the audio input in the Terminal Block.
- Audio output** - Connect an amplifier or speaker to the audio output in the Terminal Block.
- Microphone** - The camera has a built-in microphone controlled from the camera's web viewer.

**NOTE:** The camera supports either audio input OR built-in microphone (enabled by default). To use the audio-input, disable the built-in microphone in the camera's web settings.

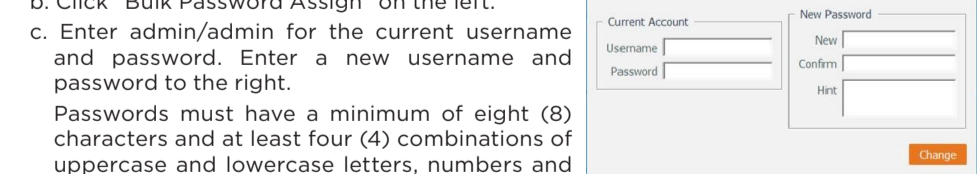
**STEP 5 - MANAGING THE SD CARD (OPTIONAL)**

- Locate the SD card slot at the base of the camera module.
- Insert a class 10 SD card into the SD card slot until it clicks into position.
- Press the card inward to release it from the card slot.

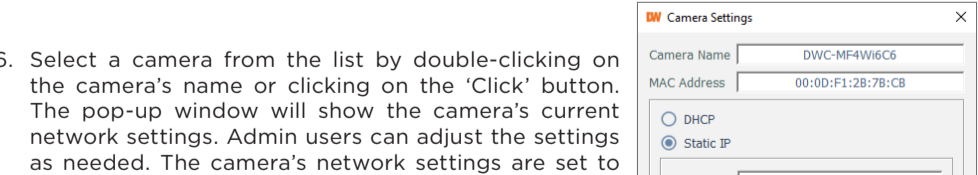

**NOTE:** Maximum SD Card size supported: Up to 1TB micro SD / FAT32. When inserting the SD card into the SD card slot, the SD card's contacts should be facing upward, as shown in the diagram.

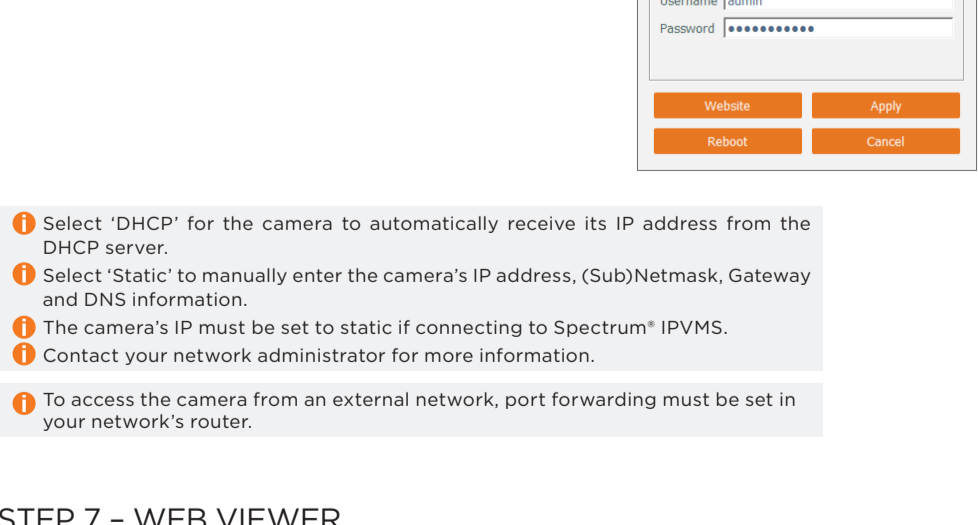
**STEP 6 - DW™ IP FINDER™**

Use the DW IP Finder software to scan the network and detect all MEGAPIX® cameras, set the camera's network settings or access the camera's web client.

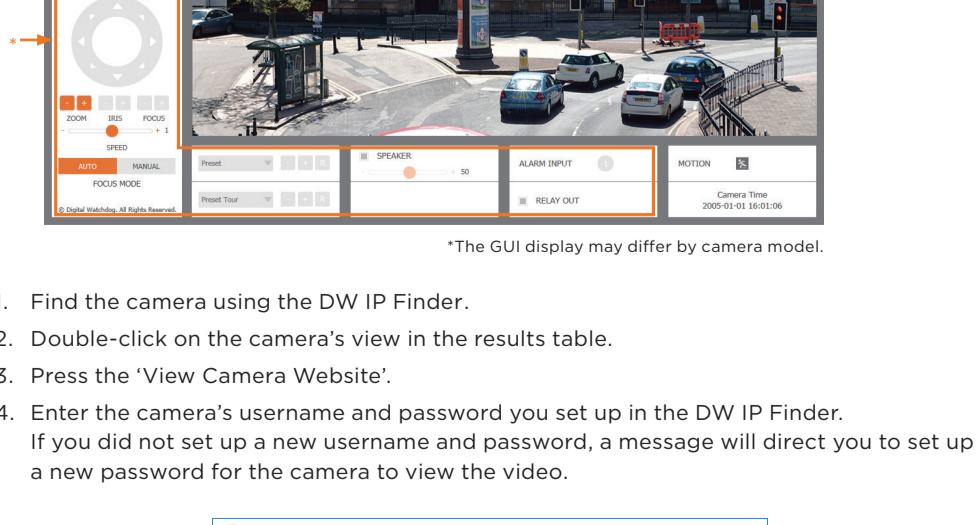

- To install the DW IP Finder, go to: <http://www.digital-watchdog.com>
- Enter "DW IP Finder" in the search box at the top of the page.
- Go to the "Software" tab on the DW IP Finder page to download and install the installation file.
- Open the DW IP Finder and click "Scan Devices." It will scan the selected network for all supported devices and list the results in the table. During the scan, the DW™ logo will turn gray.
- When connecting to the camera for the first time, a password must be set.
  - Check the box next to the camera in the IP Finder's search results. You can select multiple cameras.
  - Click "Bulk Password Assign" on the left.
  - Enter admin/admin for the current username and password. Enter a new username and password to the right.
  - Passwords must have a minimum of eight (8) characters and at least four (4) combinations of uppercase and lowercase letters, numbers and special characters. Passwords cannot contain the user ID.
  - Click "change" to apply all changes.

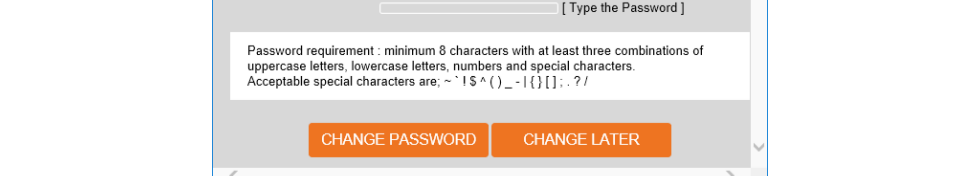

- Select a camera from the list by double-clicking on the camera's name or clicking on the 'Click' button. The pop-up window will show the camera's current network settings. Admin users can adjust the settings as needed. The camera's network settings are set to DHCP by default.
- To access the camera's web page, click on the 'Website' button.
- To save changes made to the camera's settings, enter the username and password of the camera's admin account and click 'Apply.'

- Select 'DHCP' for the camera to automatically receive its IP address from the DHCP server.
- Select 'Static' to manually enter the camera's IP address, (Sub)Netmask, Gateway and DNS information.
- The camera's IP must be set to static if connecting to Spectrum™ IPVMS.
- Contact your network administrator for more information.
- To access the camera from an external network, port forwarding must be set in your network's router.

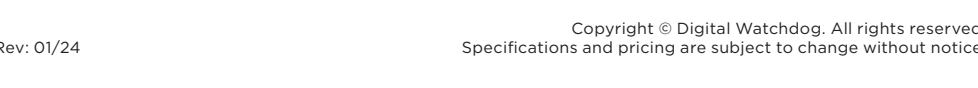
**STEP 7 - WEB VIEWER**

- Find the camera using the DW IP Finder.
- Double-click on the camera's view in the results table.
- Press the 'View Camera Website'.
- Enter the camera's username and password you set up in the DW IP Finder. If you did not set up a new username and password, a message will direct you to set up a new password for the camera to view the video.



- When accessing the camera for the first time, install the VLC player for web files to view video from the camera.

**NOTE:** Please see the full product manual for web viewer setup, functions and camera settings options.

**NOTE:** This products is covered by one or more claims of the HEVC Patents listed at: [patents.accessadvantage.com](http://patents.accessadvantage.com).

